

HLD
CLEAN
CONSULT

hld

YOUR SWISS PARTNER



HLD Clean Consult SA
Champs Montants 14 b
CH-2074 Marin



+41 32 755 73 53
+41 32 755 73 55
info@hld.ch

ULTIMATE Dx1

MADE IN EUROPE
PATENT PENDING

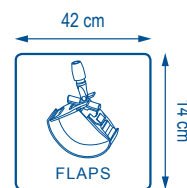
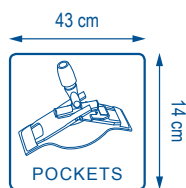
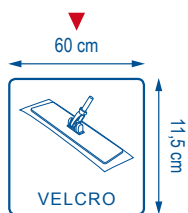
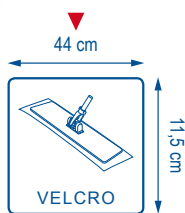

SMART TEXTILES





SMART TEXTILES

ULTIMATE Dx1

MADE IN EUROPE
PATENT PENDING

NEW GENERATION UNIVERSAL MICROFIBER MOP

Cheese or dessert? Sometimes the choice isn't easy! With *ULTIMATE* technology, there's no need to choose between performance and ergonomics. The *ULTIMATE* technology boosts efficiency (higher proportion of microfiber) and makes it glide easily over the floor. The front of the mop, with alternating design, removes dirt while the 100 % microfiber rear holds it in and absorbs grease, for a perfect finish in a single wipe.



Give up chocolate or ice-cream? Another example of a choice nobody wants to make. *ULTIMATE Dx1* solves the dilemma between European manufacturing and competitive price. The baby of the *Dx1* family was created in Europe in response to the tendering market. However, no concession has been made on the DECITEX fundamentals: the *Polyester Microfiber Velour* technology makes *ULTIMATE Dx1* a featherweight with a cleaning capacity of more than 30 m², significant resistance to chemical and temperature damage and lower laundry costs.

And its cost-effectiveness doesn't stop with the buyer, as *ULTIMATE Dx1* is designed to optimise costs at all stages. In particular, its light weight makes a difference when it comes to laundry, reducing the associated costs. The colour code facilitates logistical redistribution within the departments and, in certain countries, prevents cross-contaminations.



ULTIMATE Dx1 is designed to adapt to all floor types and can also be used to wash walls or ceilings. Its white colour allows you to see the dirt after use and the result of your work. The scrapers enhance the mechanical effect for easy removal of dirt.

It's a general-purpose bestseller.

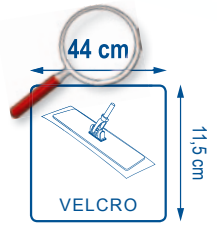

	100 770
	100 771
	100 772
	100 773
	100 829

TECHNICAL SPECIFICATIONS

95 % microfiber
(100 % polyester)
5 % polypropylène

Description:	New generation universal microfiber mop
Packaging:	Box of 10 bags of 10 Ultimate Dx1
Construction:	V.M.P. Technology (Velvet Microfiber Polyester)
Weight per m²:	650 g
Dry weight:	48 g
Weight when wrung:	123 g
Absorption rate (water):	4 Ultimate Dx1 for 1/2 L of solution
Finish:	Technical sewing
Yarn size:	0,78 dTex



PATENTED TECHNOLOGY

The **ULTIMATE** technology represents technical advancement in microfiber engineering to simultaneously **increase the proportion of pure microfiber** to increase absorption capacity and cleaning efficiency while **optimizing the ergonomic glide** across the floor surface.

ULTIMATE TECHNOLOGY

PROTECTED BY PATENT

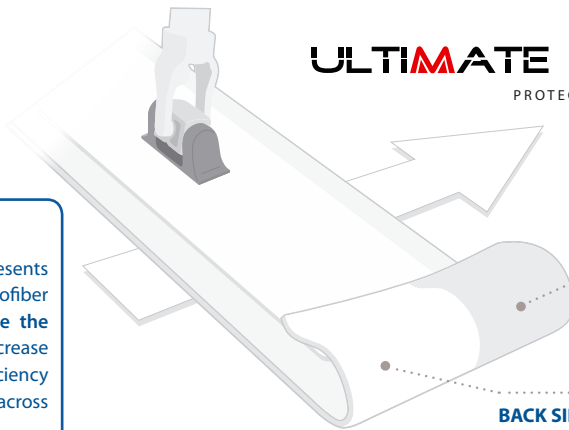

FRONT SIDE - INCREASED MECHANICAL ACTION AND GLIDE
Alternating weave of microfibers and scrubbing fibers

BACK SIDE - OPTIMIZED ADSORPTION AND SOIL REMOVAL
100% microfiber



ULTIMATE Dispomop®



ULTIMATE 3D®

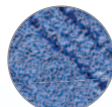

ULTIMATE M600



ULTIMATE Dx1



ULTIMATE Duo - grey



ULTIMATE Duo - white

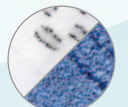

ULTIMATE DeLux



SMART TEXTILES

ULTIMATE Dx1

MADE IN EUROPE
PATENT PENDING



PROTOCOL



Operating theaters /
Intensive care
units



Healthcare



Retirement
homes



Local
authorities



Hotels



Restaurants



Cafés



Cleaning
companies



Industry

Step 1 Prepare the necessary number of Ultimate Dx1 in the bucket.

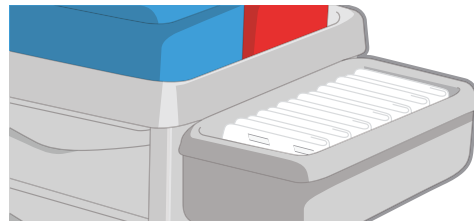

- Use the mops flat or folded -

Step 2 Pre-soak the mops as shown in the table below.



1/2 L	1 L	1 L 1/2	2 L	3 L	4 L	8 L
4 mops	8 mops	12 mops	16 mops	24 mops	32 mops	64 mops

Step 3 Wash the floors using Ultimate Dx1.

⚠ Always sweep the floor before washing.

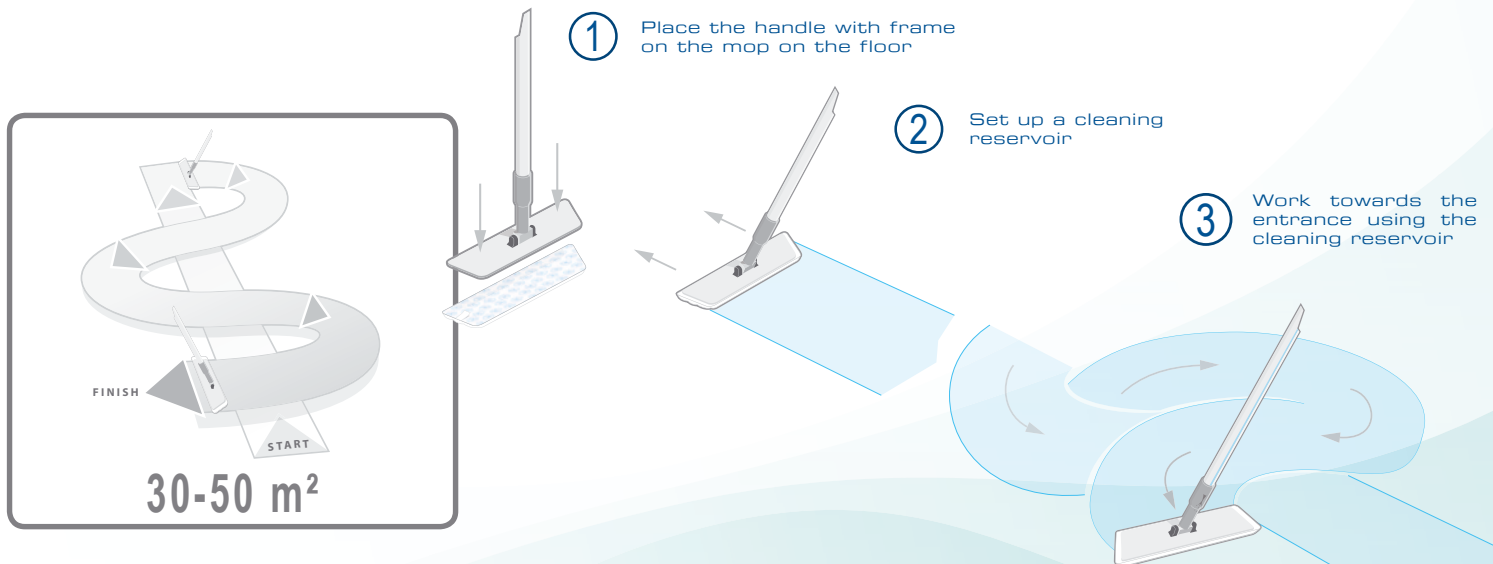



SMART TEXTILES

ULTIMATE Dx1

MADE IN EUROPE
PATENT PENDING

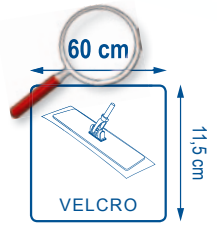

- 100 830
- 100 831
- 100 832
- 100 833
- 100 859

TECHNICAL SPECIFICATIONS

95 % microfiber
(100 % polyester)
5 % polypropylène



Description:	New generation universal microfiber mop
Packaging:	Box of 10 bags of 10 Ultimate Dx1
Construction:	V.M.P. Technology (Velvet Microfiber Polyester)
Weight per m²:	650 g
Dry weight:	65,5 g
Weight when wrung:	168 g
Absorption rate (water):	3 Ultimate Dx1 for 1/2 L of solution
Finish:	Technical sewing
Yarn size:	0,78 dTex



PATENTED TECHNOLOGY

The **ULTIMATE** technology represents technical advancement in microfiber engineering to simultaneously **increase the proportion of pure microfiber** to increase absorption capacity and cleaning efficiency while **optimizing the ergonomic glide** across the floor surface.

ULTIMATE TECHNOLOGY

PROTECTED BY PATENT

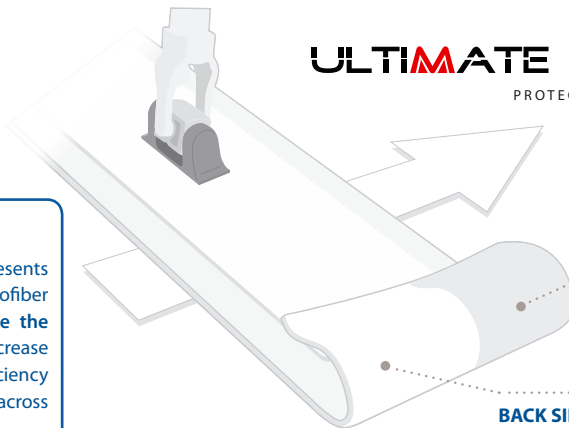

FRONT SIDE - INCREASED MECHANICAL ACTION AND GLIDE
Alternating weave of microfibers and scrubbing fibers

BACK SIDE - OPTIMIZED ADSORPTION AND SOIL REMOVAL
100% microfiber



ULTIMATE Dispomop®



ULTIMATE 3D®

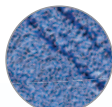

ULTIMATE M600



ULTIMATE Dx1



ULTIMATE Duo - grey



ULTIMATE Duo - white

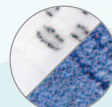

ULTIMATE DeLux



SMART TEXTILES

ULTIMATE Dx1

MADE IN EUROPE
PATENT PENDING



PROTOCOL



Operating theaters /
Intensive care
units



Healthcare



Retirement
homes



Local
authorities



Hotels



Restaurants



Cafés



Cleaning
companies



Industry

Step 1 Prepare the necessary number of Ultimate Dx1 in the bucket.

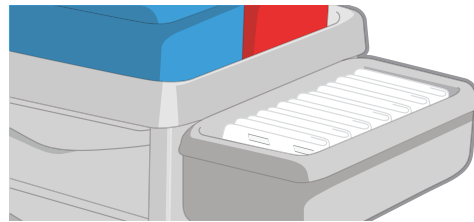

- Use the mops flat or folded -

Step 2 Pre-soak the mops as shown in the table below.



1/2 L	1 L	1 L 1/2	2 L	3 L	4 L	8 L
3 mops	6 mops	9 mops	12 mops	18 mops	24 mops	48 mops

Step 3 Wash the floors using Ultimate Dx1.

⚠ Always sweep the floor before washing.

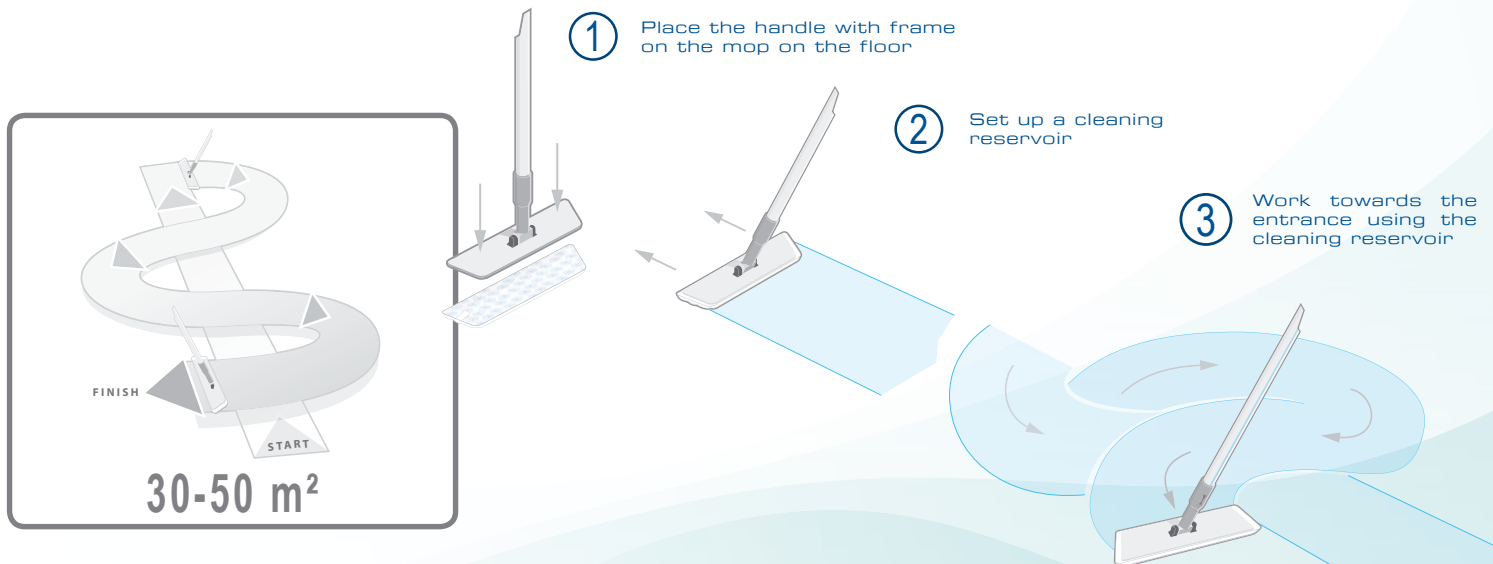



SMART TEXTILES

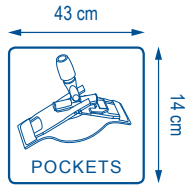

- 100 855
- 100 856
- 100 857
- 100 858
- 100 919

TECHNICAL SPECIFICATIONS

95 % microfiber
(100 % polyester)
5 % polypropylène

NO SOFTENER

x10

Description:	New generation universal microfiber mop
Packaging:	Box of 10 bags of 10 Ultimate Dx1
Construction:	V.M.P. Technology (Velvet Microfiber Polyester)
Weight per m²:	650 g
Dry weight:	72 g
Weight when wrung:	157 g
Absorption rate (water):	4 Ultimate Dx1 for 1/2 L of solution
Finish:	Technical sewing
Yarn size:	0,78 dTex



PATENTED TECHNOLOGY

The **ULTIMATE** technology represents technical advancement in microfiber engineering to simultaneously **increase the proportion of pure microfiber** to increase absorption capacity and cleaning efficiency while **optimizing the ergonomic glide** across the floor surface.

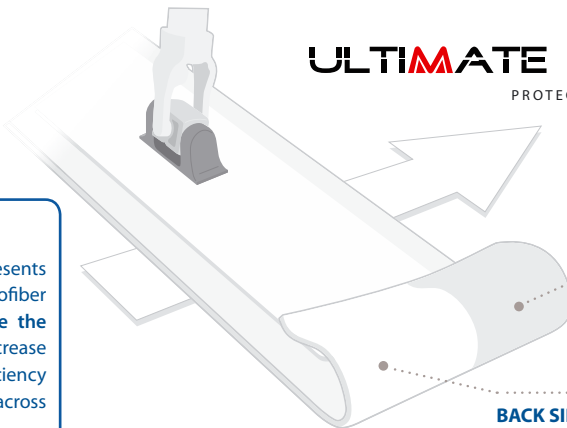

ULTIMATE TECHNOLOGY

PROTECTED BY PATENT

FRONT SIDE - INCREASED MECHANICAL ACTION AND GLIDE
Alternating weave of microfibers and scrubbing fibers

BACK SIDE - OPTIMIZED ADSORPTION AND SOIL REMOVAL
100% microfiber



ULTIMATE Dispomop®

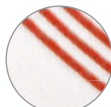

ULTIMATE 3D®

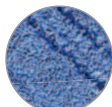

ULTIMATE M600



ULTIMATE Dx1



ULTIMATE Duo - grey



ULTIMATE Duo - white

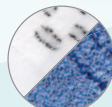

ULTIMATE DeLux



SMART TEXTILES

ULTIMATE Dx1

MADE IN EUROPE
PATENT PENDING

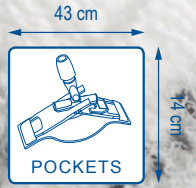

PROTOCOL



Operating theaters /
Intensive care
units



Healthcare



Retirement
homes



Local
authorities



Hotels



Restaurants



Cafés



Cleaning
companies



Industry

Step 1 Prepare the necessary number of Ultimate Dx1 in the bucket.

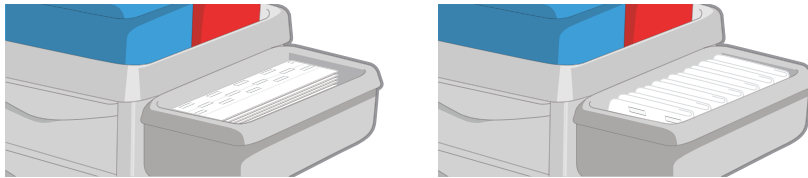

- Use the mops flat or folded -

Step 2 Pre-soak the mops as shown in the table below.



1/2 L	1 L	1 L 1/2	2 L	3 L	4 L	8 L
4 mops	8 mops	12 mops	16 mops	24 mops	32 mops	64 mops

Step 3 Wash the floors using Ultimate Dx1.

⚠ Always sweep the floor before washing.

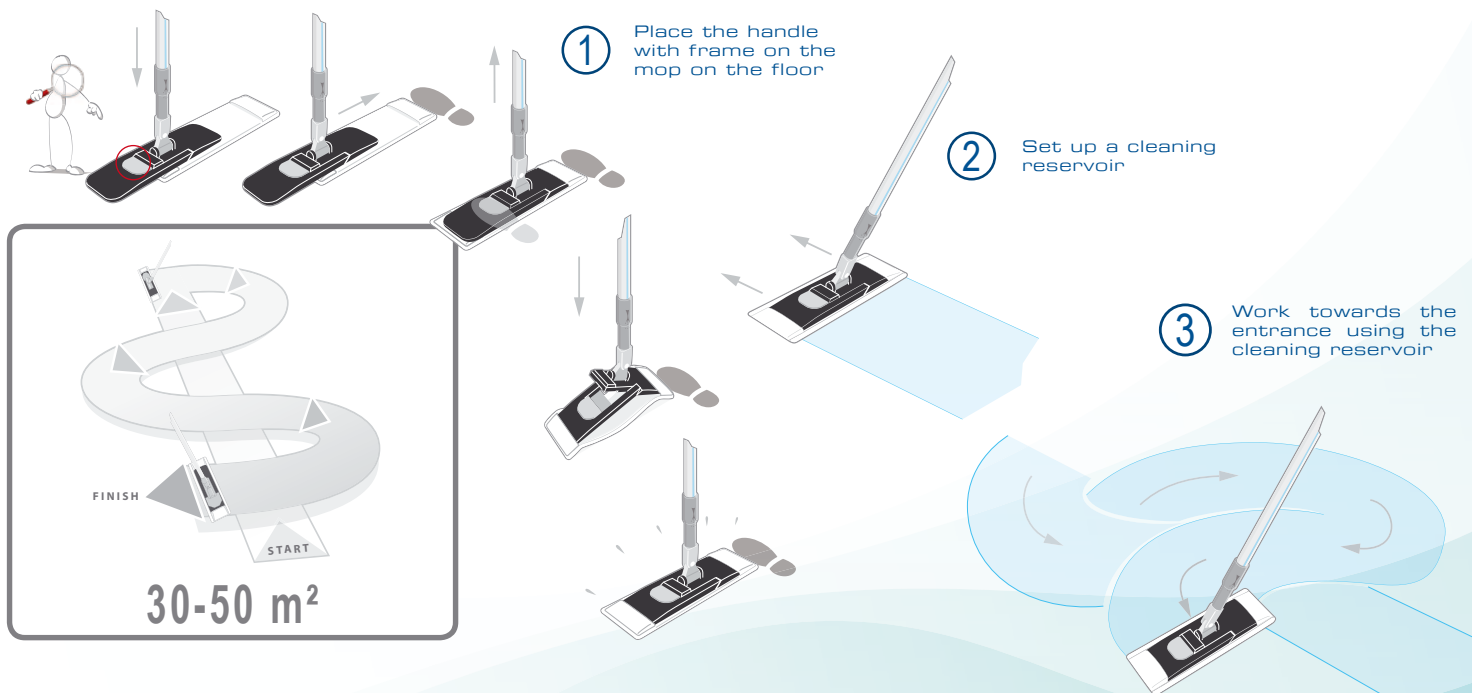



SMART TEXTILES

ULTIMATE Dx1

MADE IN EUROPE
PATENT PENDING

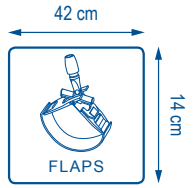

TECHNICAL SPECIFICATIONS

DEITEX 100 874

95 % microfiber
(100 % polyester)
5 % polypropylène

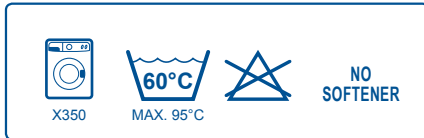

Description:	New generation universal microfiber mop
Packaging:	Box of 10 bags of 10 Ultimate Dx1
Construction:	V.M.P. Technology (Velvet Microfiber Polyester)
Weight per m²:	650 g
Dry weight:	78 g
Weight when wrung:	169 g
Absorption rate (water):	/
Finish:	Technical sewing
Yarn size:	0,78 dTex



PATENTED TECHNOLOGY

The **ULTIMATE** technology represents technical advancement in microfiber engineering to simultaneously **increase the proportion of pure microfiber** to increase absorption capacity and cleaning efficiency while **optimizing the ergonomic glide** across the floor surface.

ULTIMATE TECHNOLOGY

PROTECTED BY PATENT

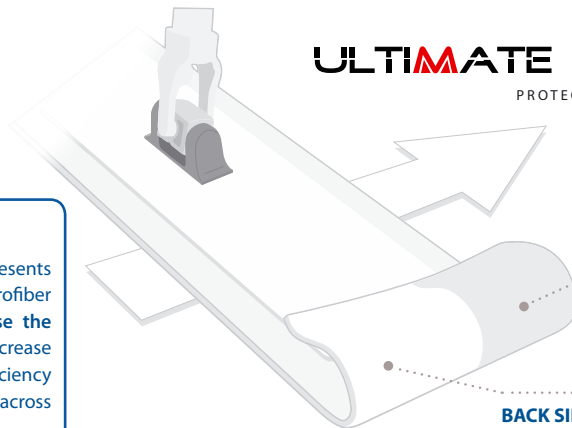

FRONT SIDE - INCREASED MECHANICAL ACTION AND GLIDE
Alternating weave of microfibers and scrubbing fibers

BACK SIDE - OPTIMIZED ADSORPTION AND SOIL REMOVAL
100% microfiber



ULTIMATE Dispomop®

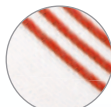

ULTIMATE 3D®

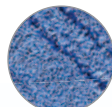

ULTIMATE M600



ULTIMATE Dx1



ULTIMATE Duo - grey



ULTIMATE Duo - white

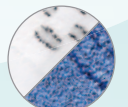

ULTIMATE DeLux



ULTIMATE Dx1

MADE IN EUROPE
PATENT PENDING

SMART TEXTILES

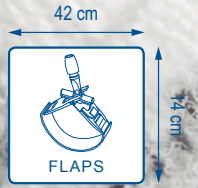

PROTOCOL



Operating theaters / Intensive care units



Healthcare



Retirement homes



Local authorities



Hotels



Restaurants



Cafés



Cleaning companies



Industry

1

Soak the mop



2

Squeeze the mop in the squeeze bucket



3

Work towards the entrance using the cleaning reservoir

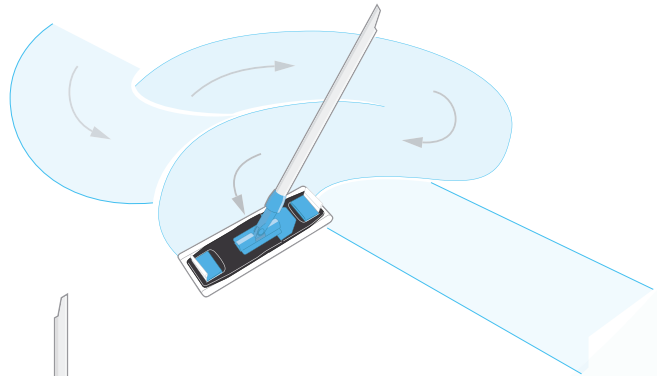

Always sweep the floor before washing.

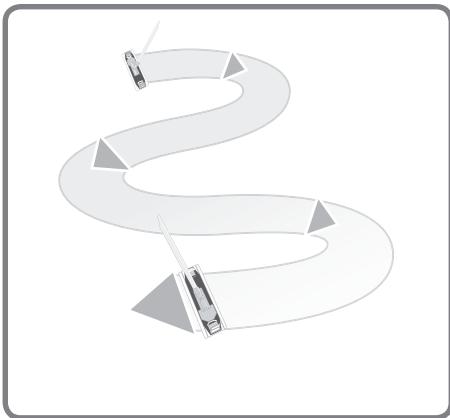

4

Soak and squeeze the mop in the squeeze bucket to continue cleaning

