

# ***Ergoflex***

55 cm



SMART TEXTILES





SMART TEXTILES

**Ergoflex**



## FLEXIBLE HANDLE TO CLEAN HARD TO REACH PLACES

Straight as a die or all twisted, *Ergoflex* is a contortionist! It tackles the most unlikely hard-to-reach places where you would never dream of putting your hands. It's really useful when covered with a sleeve, either disposable, *Dispocover*, or washable 300 times, *Ergodust*.

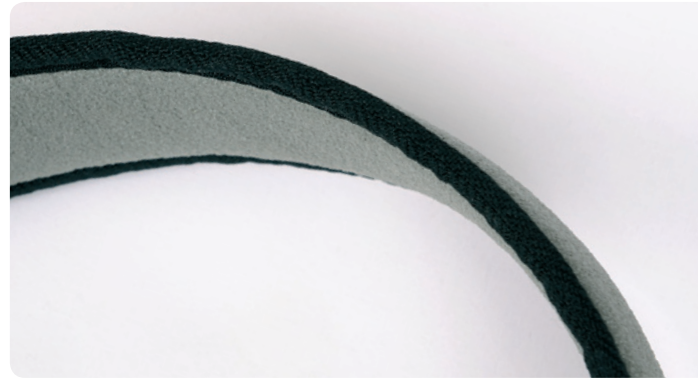

Once united, *Ergoflex* and its sleeve need nothing else. Not even need water as they do the job dry by electrostatic force, attracting the dust from all its hiding places.



By connecting a telescopic handle from the DECITEX range in place of the handle (*Mini* 77 cm or standard 1.60 m), you can dust in complete safety, even high up, with both feet on the floor.

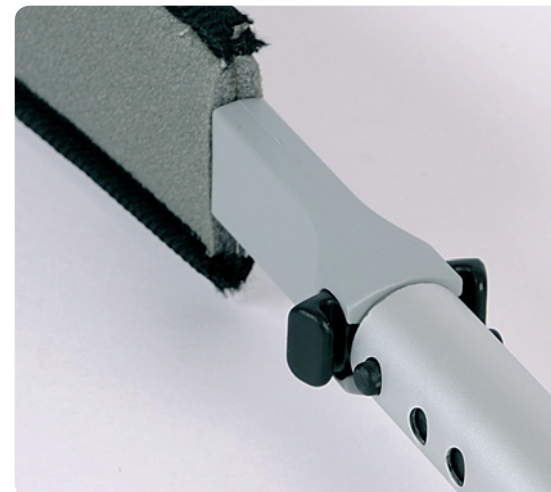

*Ergoflex* is an essential ergonomic tool for dusting behind radiators, on top of furniture, televisions and even doors. It can also reach the most crucial places equipped with its disposable sleeve, *Dispocover*, for example to clean on top of lamps in operating theatres. Another addictive innovation from the first use!



SMART TEXTILES

# Ergoflex

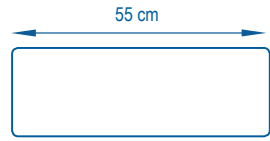

## TECHNICAL SPECIFICATIONS



100 854

Plastic and  
Aluminium



**Description:** Flexible handle to clean hard to reach places

**Packaging:** Box of 10 Ergoflex

**Counterpart:** Three hydrophobic layers

55 cm

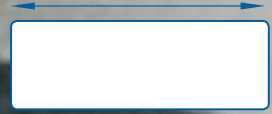

## PROTOCOL



Operating theaters /  
Intensive care  
units



Healthcare



Retirement  
homes



Local  
authorities



Hotels



Restaurants



Cafés



Cleaning  
companies



Industry

- 1** Slip one of the two microfiber sleeves in the range onto the flexible handle

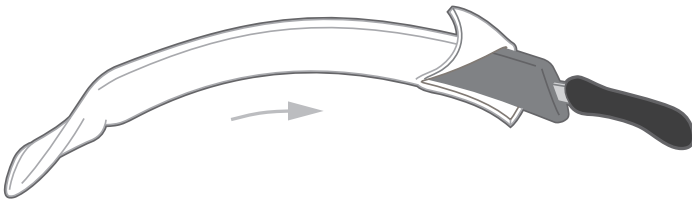

- 2** Adjust the curve of the flexible handle to suit

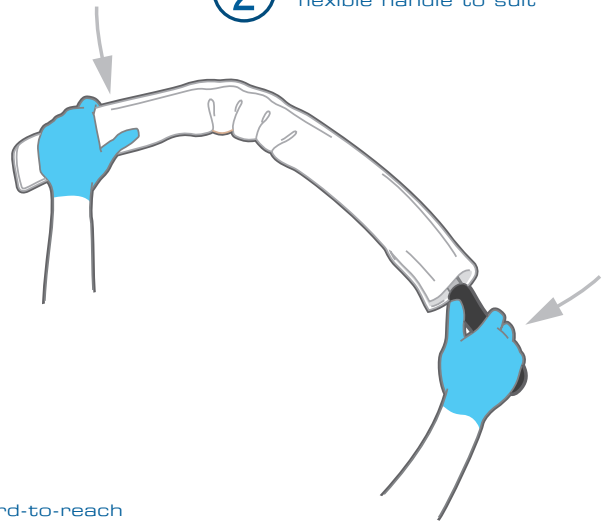

- 3** Clean high and hard-to-reach areas easily

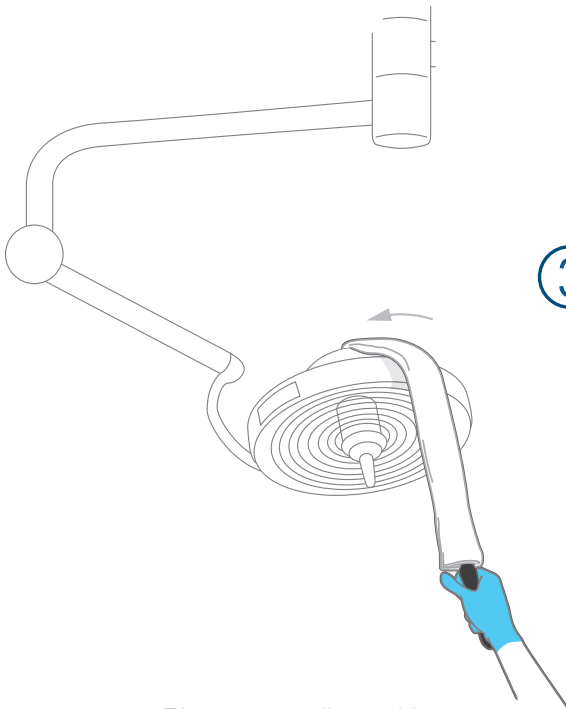

Dispocover - disposable  
microfiber sleeve

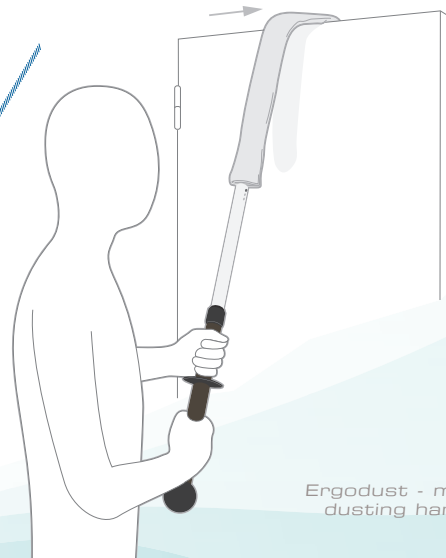

Ergodust - microfiber sleeve for  
dusting hard-to-reach places

Use the Ergoflex with the Mini Telescopic Handle to prevent musculoskeletal disorders (MSD)