

HLD
CLEAN
CONSULT

hld

YOUR SWISS PARTNER



HLD Clean Consult SA
Champs Montants 14 b
CH-2074 Marin



+41 32 755 73 53



+41 32 755 73 55



info@hld.ch

ULTIMATE Duo - white

MADE IN EUROPE
PATENT PENDING

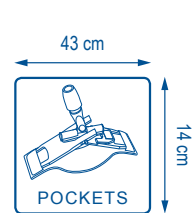
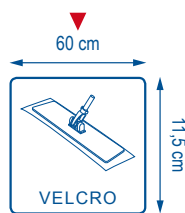
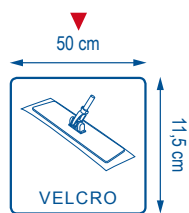
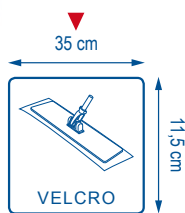

SMART TEXTILES





SMART TEXTILES

ULTIMATE Duo - white

MADE IN EUROPE
PATENT PENDING

PREMIUM MICROFIBER MOP - EFFECTIVE EVEN ON NON-SLIP FLOORING

Safety first, hygiene second... That's the implicit choice you made when choosing your non-slip floor, which is a daily cleaning headache. You're not alone! It's reassuring but that's not enough, which is why DECITEX is offering you the solution you've been waiting so long for. And that's not all!



As the name suggests, *ULTIMATE Duo - white* uses the patented *ULTIMATE* technology. Thanks to its rigid filaments that work against the pile, the front of *ULTIMATE Duo - white* (everted side edge) lifts dirt and holds it within its microfiber system, never to let it go. This front side eases the glide on non-slip floors. The softer rear, made of 100 % microfiber, finishes the job perfectly.

He who can do more...

ULTIMATE Duo - white is the most versatile mop in the range and its everted rim will even pick up dirt from along plinths. It also comes in grey (*ULTIMATE Duo - grey*) for electrostatic dry mopping, the white one is more dedicated to the wet mop stage but that's up to you!



ULTIMATE Duo - white is very dense (950 g / m²) so it can cover surfaces from 50 to more than 100 m² depending on the level of dirt. It's built to last more than 500 washes and thanks to its range of four colours, it can be allocated by work area or facilitate logistical redistribution within your department.



SMART TEXTILES

ULTIMATE Duo - white

MADE IN EUROPE
PATENT PENDING

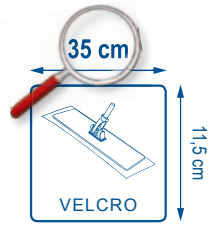

- 100 837
- 100 838
- 100 839
- 100 840

TECHNICAL SPECIFICATIONS

80 % microfiber
(100 % polyester)
20 % polyester

| | |
|----------------------------------|--|
| Description: | Premium microfiber mop - effective even on non-slip flooring |
| Packaging: | Box of 10 bags of 10 Ultimate Duo - white |
| Construction: | V.M.P. Technology (Velvet Microfiber Polyester) |
| Weight per m²: | 950 g |
| Dry weight: | 57,5 g |
| Weight when wrung: | 140 g |
| Absorption rate (water): | 3 Ultimate Duo - white for 1/2 L of solution |
| Finish: | Technical sewing |
| Yarn size: | 0,56 dTex |



PATENTED TECHNOLOGY

The **ULTIMATE** technology represents technical advancement in microfiber engineering to simultaneously **increase the proportion of pure microfiber** to increase absorption capacity and cleaning efficiency while **optimizing the ergonomic glide** across the floor surface.

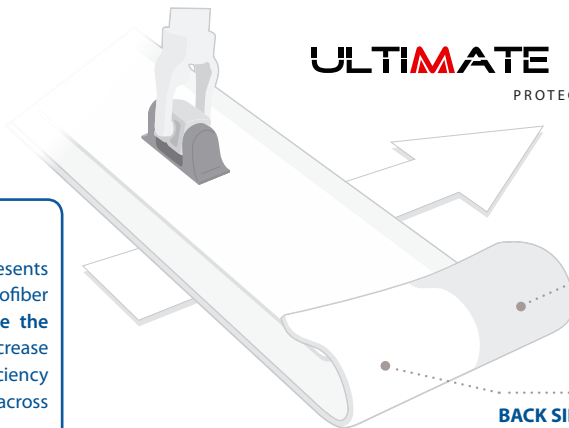

ULTIMATE TECHNOLOGY

PROTECTED BY PATENT

FRONT SIDE - INCREASED MECHANICAL ACTION AND GLIDE
Alternating weave of microfibers and scrubbing fibers

BACK SIDE - OPTIMIZED ADSORPTION AND SOIL REMOVAL
100% microfiber

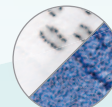
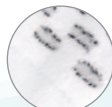
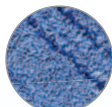
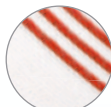

ULTIMATE Dispomop®

ULTIMATE 3D®

ULTIMATE M600

ULTIMATE Dx1

ULTIMATE Duo - grey

ULTIMATE Duo - white

ULTIMATE DeLux



SMART TEXTILES

ULTIMATE Duo - white

MADE IN EUROPE
PATENT PENDING



PROTOCOL



Healthcare



Retirement homes



Local authorities



Hotels



Restaurants



Cafés

Step 1 Prepare the necessary number of Ultimate Duo - white in the bucket.

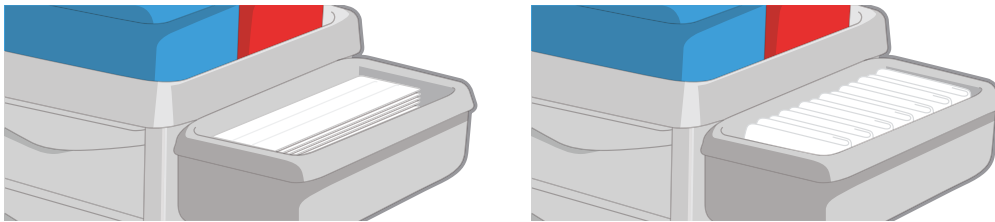

- Use the mops flat or folded -

Step 2 Pre-soak the mops as shown in the table below.



| | | | | | | |
|--------|--------|---------|---------|---------|---------|---------|
| 1/2 L | 1 L | 1 L 1/2 | 2 L | 3 L | 4 L | 8 L |
| 3 mops | 6 mops | 9 mops | 12 mops | 18 mops | 24 mops | 48 mops |

Step 3 Wash the floors using Ultimate Duo - white.

⚠ Always sweep the floor before washing.

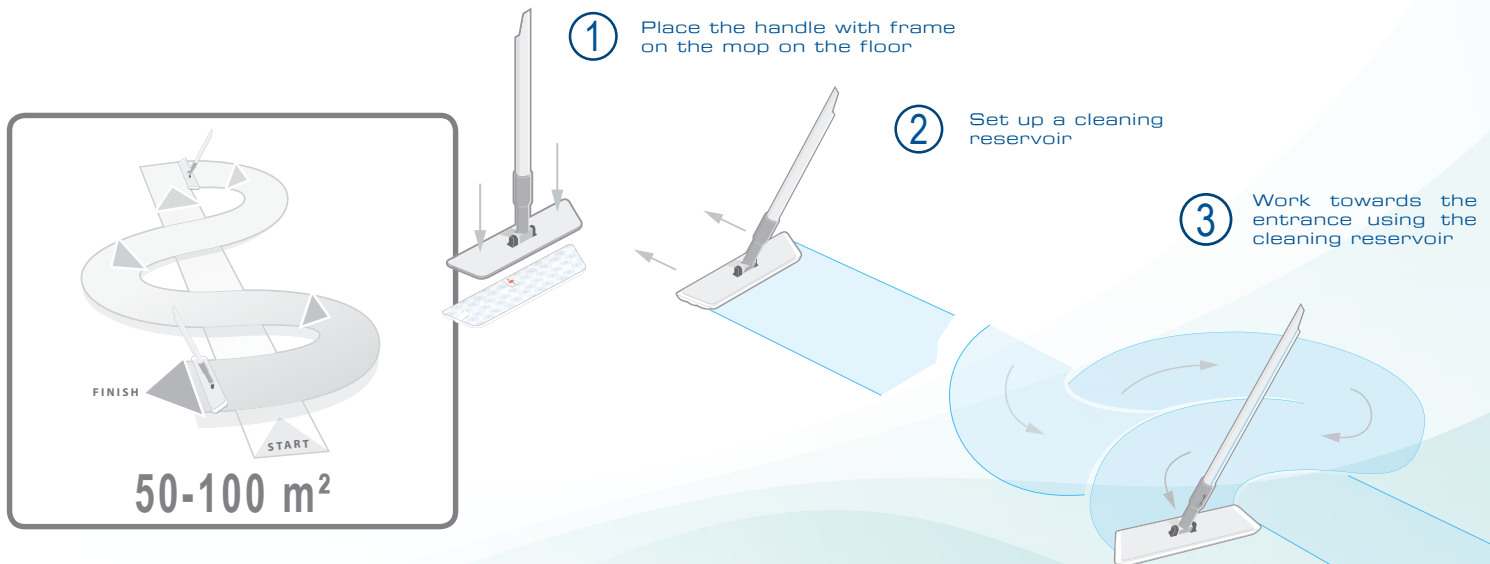





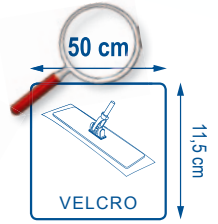

SMART TEXTILES

ULTIMATE Duo - white





MADE IN EUROPE
PATENT PENDING



-  100 766
-  100 767
-  100 768
-  100 769

TECHNICAL SPECIFICATIONS

80 % microfiber
(100 % polyester)
20 % polyester

 X600
 60°C
 NO SOFTENER
 x10

| | |
|----------------------------------|--|
| Description: | Premium microfiber mop - effective even on non-slip flooring |
| Packaging: | Box of 10 bags of 10 Ultimate Duo - white |
| Construction: | V.M.P. Technology (Velvet Microfiber Polyester) |
| Weight per m²: | 950 g |
| Dry weight: | 82 g |
| Weight when wrung: | 200 g |
| Absorption rate (water): | 2 Ultimate Duo - white for 1/2 L of solution |
| Finish: | Technical sewing |
| Yarn size: | 0,56 dTex |



PATENTED TECHNOLOGY

The **ULTIMATE** technology represents technical advancement in microfiber engineering to simultaneously **increase the proportion of pure microfiber** to increase absorption capacity and cleaning efficiency while **optimizing the ergonomic glide** across the floor surface.

ULTIMATE TECHNOLOGY

PROTECTED BY PATENT

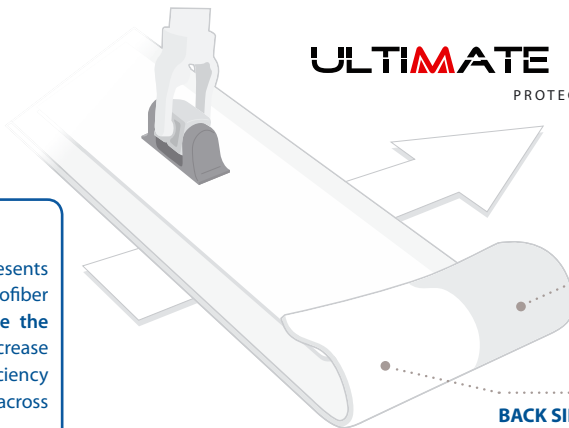

FRONT SIDE - INCREASED MECHANICAL ACTION AND GLIDE
Alternating weave of microfibers and scrubbing fibers

BACK SIDE - OPTIMIZED ADSORPTION AND SOIL REMOVAL
100% microfiber



ULTIMATE Dispomop®



ULTIMATE 3D*

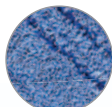

ULTIMATE M600



ULTIMATE Dx1



ULTIMATE Duo - grey



ULTIMATE Duo - white

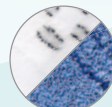

ULTIMATE DeLux



SMART TEXTILES

ULTIMATE Duo - white

MADE IN EUROPE
PATENT PENDING

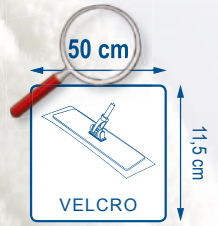

PROTOCOL



Healthcare



Retirement homes



Local authorities



Hotels



Restaurants



Cafés

Step 1 Prepare the necessary number of Ultimate Duo - white in the bucket.

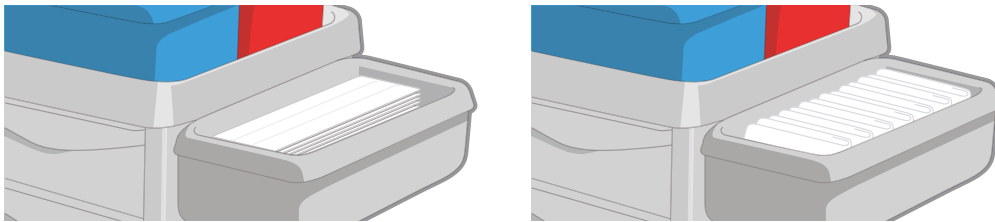

- Use the mops flat or folded -

Step 2 Pre-soak the mops as shown in the table below.



| | | | | | | |
|--------|--------|---------|--------|---------|---------|---------|
| 1/2 L | 1 L | 1 L 1/2 | 2 L | 3 L | 4 L | 8 L |
| 2 mops | 4 mops | 6 mops | 8 mops | 12 mops | 16 mops | 32 mops |

Step 3 Wash the floors using Ultimate Duo - white.

⚠ Always sweep the floor before washing.

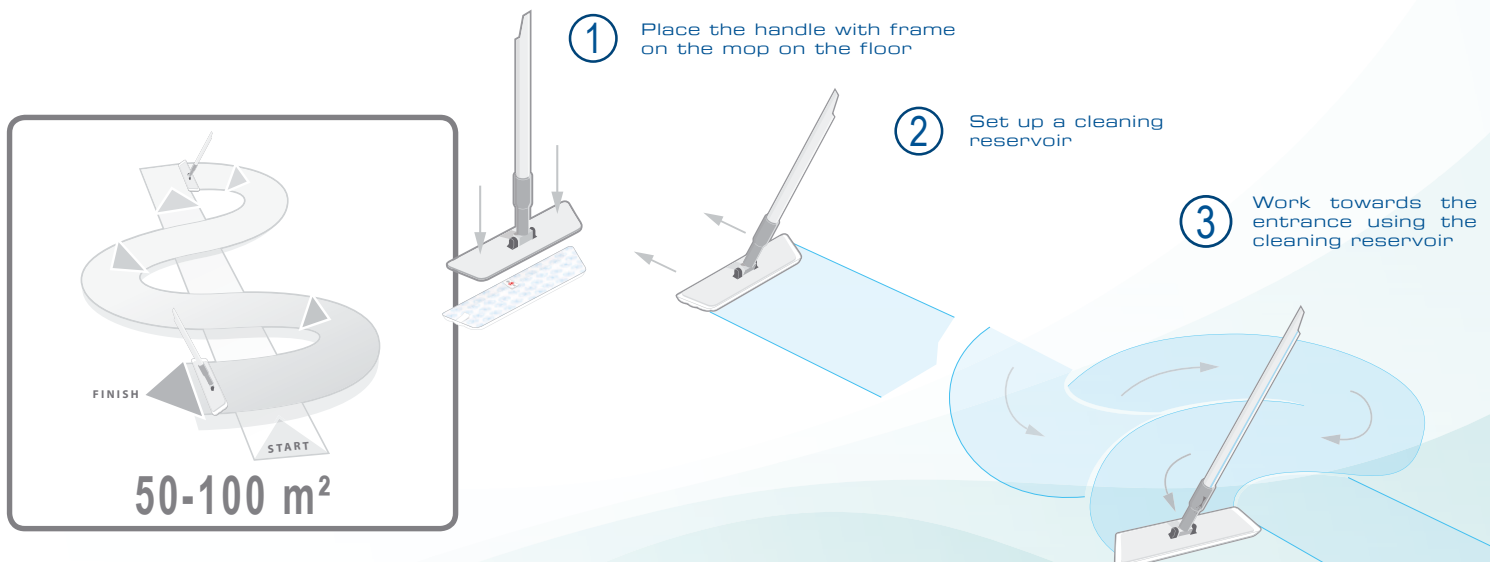





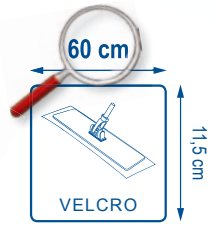

SMART TEXTILES

ULTIMATE Duo - white



MADE IN EUROPE
PATENT PENDING



-  100 841
-  100 842
-  100 843
-  100 844

TECHNICAL SPECIFICATIONS

80 % microfiber
(100 % polyester)
20 % polyester

 X600
 60°C
 NO SOFTENER



| | |
|----------------------------------|--|
| Description: | Premium microfiber mop - effective even on non-slip flooring |
| Packaging: | Box of 10 bags of 10 Ultimate Duo - white |
| Construction: | V.M.P. Technology (Velvet Microfiber Polyester) |
| Weight per m²: | 950 g |
| Dry weight: | 98,5 g |
| Weight when wrung: | 240 g |
| Absorption rate (water): | 1 Ultimate Duo - white for 1/2 L of solution |
| Finish: | Technical sewing |
| Yarn size: | 0,56 dTex |



PATENTED TECHNOLOGY

The **ULTIMATE** technology represents technical advancement in microfiber engineering to simultaneously **increase the proportion of pure microfiber** to increase absorption capacity and cleaning efficiency while **optimizing the ergonomic glide** across the floor surface.

ULTIMATE TECHNOLOGY

PROTECTED BY PATENT

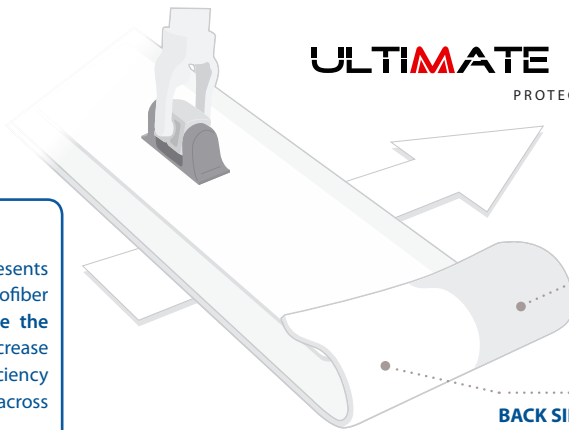

FRONT SIDE - INCREASED MECHANICAL ACTION AND GLIDE
Alternating weave of microfibers and scrubbing fibers

BACK SIDE - OPTIMIZED ADSORPTION AND SOIL REMOVAL
100% microfiber



ULTIMATE Dispomop®



ULTIMATE 3D®

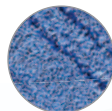

ULTIMATE M600



ULTIMATE Dx1



ULTIMATE Duo - grey



ULTIMATE Duo - white

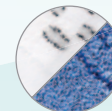

ULTIMATE DeLux



SMART TEXTILES

ULTIMATE Duo - white

MADE IN EUROPE
PATENT PENDING

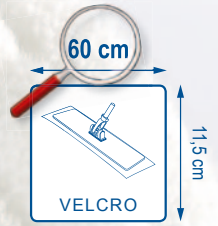

PROTOCOL



Healthcare



Retirement homes



Local authorities



Hotels



Restaurants



Cafés

Step 1 Prepare the necessary number of Ultimate Duo - white in the bucket.

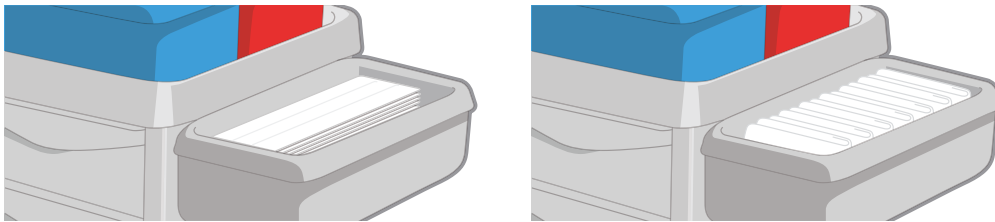

- Use the mops flat or folded -

Step 2 Pre-soak the mops as shown in the table below.



| | | | | | | |
|--------|--------|---------|--------|--------|--------|---------|
| 1/2 L | 1 L | 1 L 1/2 | 2 L | 3 L | 4 L | 8 L |
| 1 mops | 2 mops | 3 mops | 4 mops | 6 mops | 8 mops | 16 mops |

Step 3 Wash the floors using Ultimate Duo - white.

⚠ Always sweep the floor before washing.

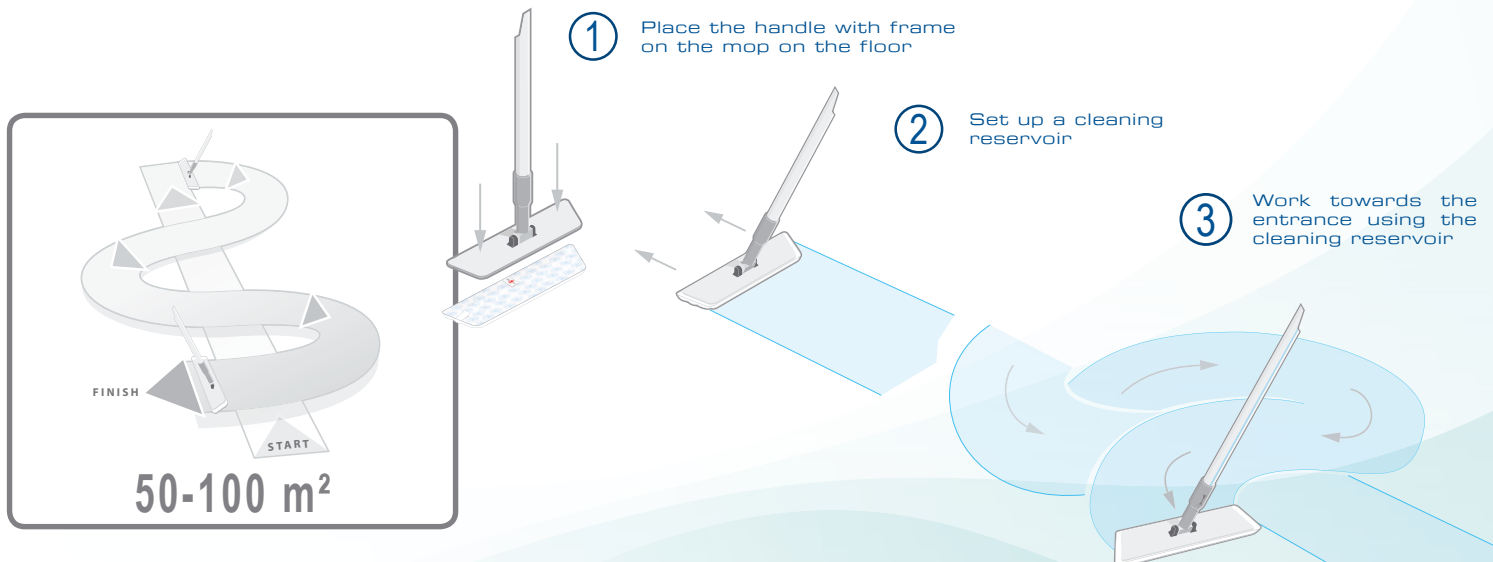





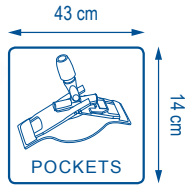

SMART TEXTILES

ULTIMATE Duo - white



MADE IN EUROPE
PATENT PENDING



-  100 847
-  100 848
-  100 849
-  100 850

TECHNICAL SPECIFICATIONS

80 % microfiber
(100 % polyester)
20 % polyester

 X600
 60°C
 NO SOFTENER



| | |
|----------------------------------|--|
| Description: | Premium microfiber mop - effective even on non-slip flooring |
| Packaging: | Box of 10 bags of 10 Ultimate Duo - white |
| Construction: | V.M.P. Technology (Velvet Microfiber Polyester) |
| Weight per m²: | 950 g |
| Dry weight: | 106 g |
| Weight when wrung: | 235 g |
| Absorption rate (water): | 2 Ultimate Duo - white for 1/2 L of solution |
| Finish: | Technical sewing |
| Yarn size: | 0,56 dTex |



PATENTED TECHNOLOGY

The **ULTIMATE** technology represents technical advancement in microfiber engineering to simultaneously **increase the proportion of pure microfiber** to increase absorption capacity and cleaning efficiency while **optimizing the ergonomic glide** across the floor surface.

ULTIMATE TECHNOLOGY

PROTECTED BY PATENT

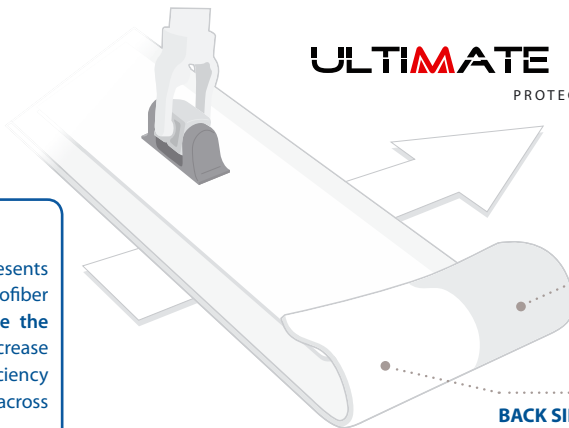

FRONT SIDE - INCREASED MECHANICAL ACTION AND GLIDE
Alternating weave of microfibers and scrubbing fibers

BACK SIDE - OPTIMIZED ADSORPTION AND SOIL REMOVAL
100% microfiber

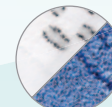
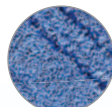
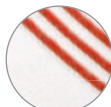

ULTIMATE Dispomop®

ULTIMATE 3D®

ULTIMATE M600

ULTIMATE Dx1

ULTIMATE Duo - grey

ULTIMATE Duo - white

ULTIMATE DeLux



SMART TEXTILES

ULTIMATE Duo - white

MADE IN EUROPE
PATENT PENDING

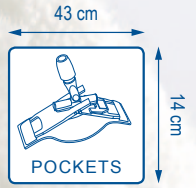

PROTOCOL



Healthcare



Retirement homes



Local authorities



Hotels



Restaurants



Cafés

Step 1 Prepare the necessary number of Ultimate Duo - white in the bucket.

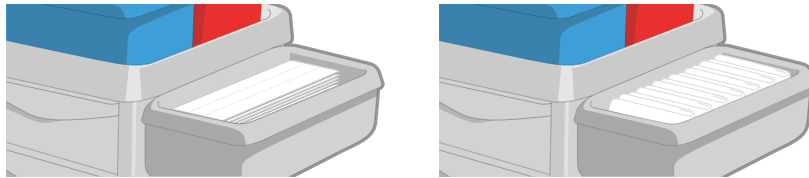

- Use the mops flat or folded -

Step 2 Pre-soak the mops as shown in the table below.



| | | | | | | |
|--------|--------|---------|--------|---------|---------|---------|
| 1/2 L | 1 L | 1 L 1/2 | 2 L | 3 L | 4 L | 8 L |
| 2 mops | 4 mops | 6 mops | 8 mops | 12 mops | 16 mops | 32 mops |

Step 3 Wash the floors using Ultimate Duo - white.

Always sweep the floor before washing.

