

HLD
CLEAN
CONSULT

hld

VOTRE PARTENAIRE SUISSE 

HLD Clean Consult SA
Champs Montants 14 b
CH-2074 Marin

 +41 32 755 73 53
 +41 32 755 73 55
 info@hld.ch

ULTIMATE M600

 FABRIQUÉ EN EUROPE
BREVET DÉPOSÉ

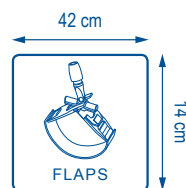
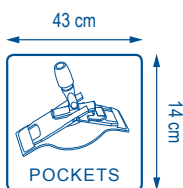
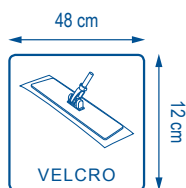

SMART TEXTILES





SMART TEXTILES

ULTIMATE M600

FABRIQUÉ EN EUROPE
BREVET DÉPOSÉ

MOP MICROFIBRE DE NETTOYAGE VAPEUR ET SOLS LISSES NOUVELLE GÉNÉRATION

La M600, sa grande sœur, est avant tout connue pour être une mop d'absorption capable de laisser très peu d'eau sur la surface. Sa couche intermédiaire 100 % microfibre lui garantit une réserve d'absorption supplémentaire pour le nettoyage de grandes surfaces. C'est la mop idéale en association avec un matériel vapeur ou sur les carrelages brillants.

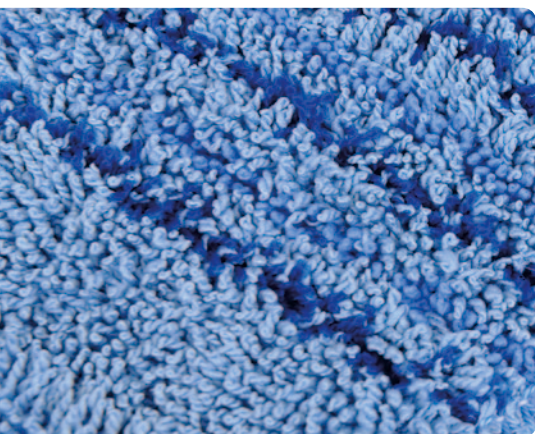

La dernière-née, L'ULTIMATE M600 bénéficie donc de tous les avantages de la M600 et y ajoute tous ceux de la technologie ULTIMATE brevetée. Plus besoin de choisir entre performance et ergonomie : avec plus de microfibre, la technologie ULTIMATE booste l'efficacité et facilite la glisse au sol. L'avant de la mop, au design alterné, décroche les salissures et l'arrière 100 % microfibre les retient tout en absorbant les corps gras.

L'ULTIMATE M600 bénéficie d'une tri-composition ! En plus de la bi-composition de la M600 (50 % de microfibre pour l'absorption et le décrochage des salissures et 50 % de polyester pour faciliter la glisse au sol) l'ULTIMATE M600 s'est vue dotée d'un fil de polypropylène pour renforcer l'effet mécanique et décrocher les salissures les plus tenaces.

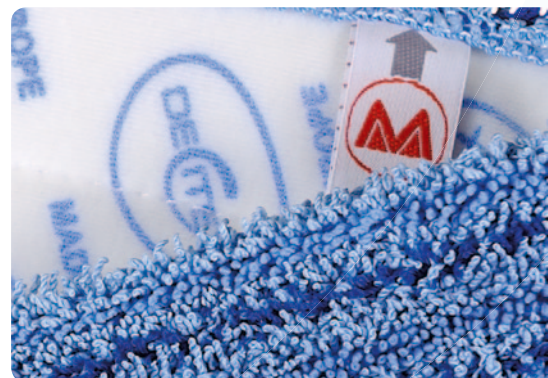

Munie de quatre rubans de couleurs, vous pourrez l'affecter par zone de travail ou faciliter la redistribution logistique dans votre service.

Contrairement à la majorité des acteurs présents sur ce marché, DECITEX fabrique l'ULTIMATE M600 en Europe dans ses propres ateliers. C'est ainsi que nous garantissons la qualité de l'ULTIMATE M600 année après année.

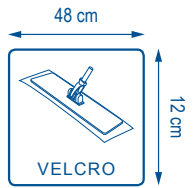

CARACTÉRISTIQUES TECHNIQUES

DECITEX 100 756

70 % microfibre
(80 % polyester /
20 % polyamide)
20 % polyester
10 % polypropylène

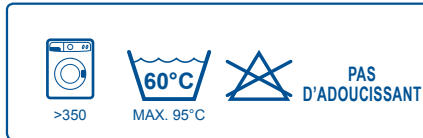

Description : Mop microfibre de nettoyage vapeur et sols lisses nouvelle génération
Conditionnement : Cartons de 10 sachets de 10 Ultimate M600
Construction : Tricot à plat
Poids au m² : 520 g
Poids sec : 75 g
Poids essoré : 185 g
Imprégnation : 2 Ultimate M600 pour 1/2 L de solution
Finition : Surjet technique
Finesse du fil : 0,20 dTex



TECHNOLOGIE BREVETÉE

L'ULTIMATE est la seule technologie capable d'augmenter la proportion de microfibre pour plus d'efficacité sans affecter la glisse au sol pour plus d'ergonomie.

TECHNOLOGIE ULTIMATE

BREVET DÉPOSÉ

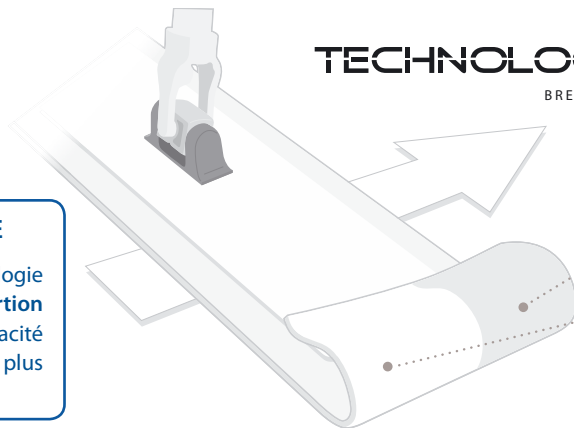

CÔTÉ QUI FACILITE LA GLISSE
Alternance de microfibrilles et fibres grattantes

CÔTÉ QUI DÉGRAISSE EN PROFONDEUR
100 % microfibre



ULTIMATE Dispomop®



ULTIMATE 3D

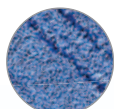

ULTIMATE M600



ULTIMATE Dx1



ULTIMATE Duo - grey



ULTIMATE Duo - white

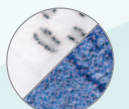

ULTIMATE DeLux



SMART TEXTILES

ULTIMATE M600

FABRIQUÉ EN EUROPE
BREVET DÉPOSÉ

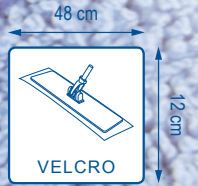

PROTOCOLE



Blocs opératoires /
Services de réanimation



Services de santé



Maisons de retraite



Collectivités



Hôtels



Restaurants



Cafés



Entreprises de propreté



Industries

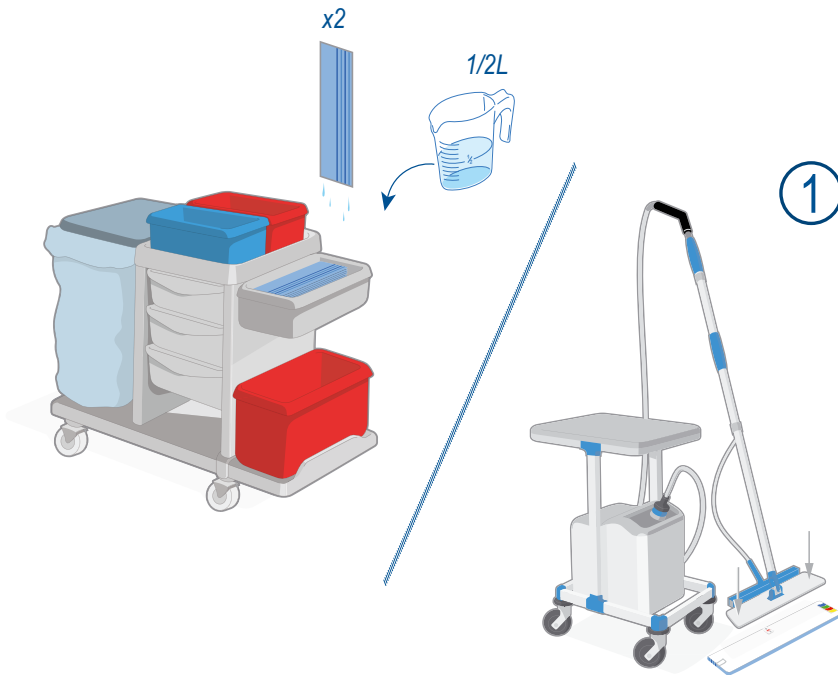

① Positionner le balai vapeur sur la mop au sol

② Actionner le balai vapeur

③ Procéder au nettoyage du sol en commençant par le fond de la pièce pour revenir ensuite vers l'entrée

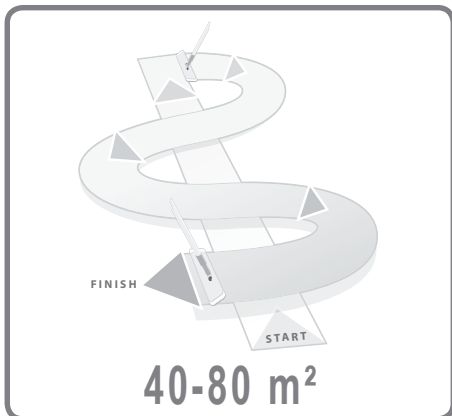



SMART TEXTILES

ULTIMATE M600

FABRIQUÉ EN EUROPE
BREVET DÉPOSÉ

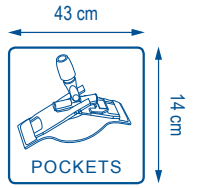

CARACTÉRISTIQUES TECHNIQUES

DEITEX 100 835

70 % microfibre
(80 % polyester /
20 % polyamide)
20 % polyester
10 % polypropylène

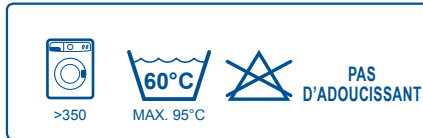

Description : Mop microfibre de nettoyage vapeur et sols lisses nouvelle génération

Conditionnement : Cartons de 10 sachets de 10 Ultimate M600

Construction : Tricot à plat

Poids au m² : 520 g

Poids sec : 88 g

Poids essoré : 200 g

Imprégnation : 2 Ultimate M600 pour 1/2 L de solution

Finition : Surjet technique

Finesse du fil : 0,20 dTex



TECHNOLOGIE BREVETÉE

L'ULTIMATE est la seule technologie capable d'augmenter la proportion de microfibre pour plus d'efficacité sans affecter la glisse au sol pour plus d'ergonomie.

TECHNOLOGIE ULTIMATE

BREVET DÉPOSÉ

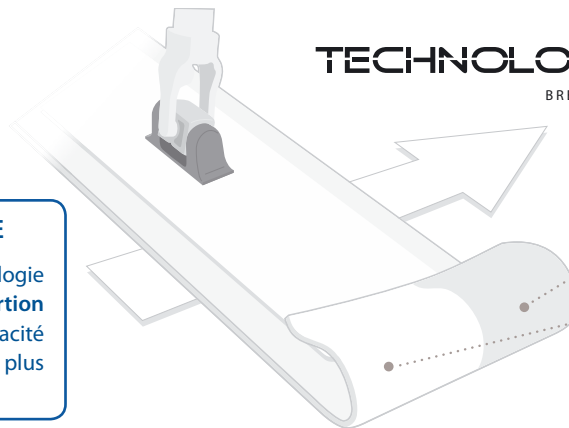

CÔTÉ QUI FACILITE LA GLISSE
Alternance de microfibras et fibres grattantes

CÔTÉ QUI DÉGRAISSE EN PROFONDEUR
100 % microfibre



ULTIMATE Dispomop®



ULTIMATE 3D®

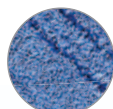

ULTIMATE M600



ULTIMATE Dx1



ULTIMATE Duo - grey



ULTIMATE Duo - white

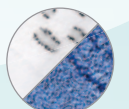

ULTIMATE DeLux



SMART TEXTILES

ULTIMATE M600

FABRIQUÉ EN EUROPE
BREVET DÉPOSÉ

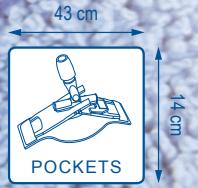

PROTOCOLE



Blocs opératoires / Services de réanimation



Services de santé



Maisons de retraite



Collectivités



Hôtels



Restaurants



Cafés



Entreprises de propreté



Industries

Étape 1 Préparer le nombre nécessaire d'Ultimate M600 dans le bac.

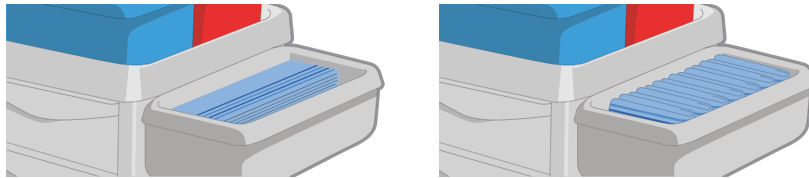

- disposition des mops à plat ou pliée pour une utilisation à poches -

Étape 2 Pré-imbiber les mops en se référant au tableau ci-dessous.



1/2 L	1 L	1 L 1/2	2 L	3 L	4 L	8 L
2 mops	4 mops	6 mops	8 mops	12 mops	16 mops	32 mops

Étape 3 Lavage des sols avec la Ultimate M600.

⚠ Précéder toujours le lavage d'un balayage.





SMART TEXTILES

ULTIMATE M600

FABRIQUÉ EN EUROPE
BREVET DÉPOSÉ

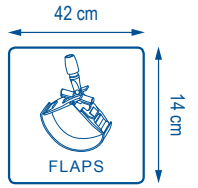

CARACTÉRISTIQUES TECHNIQUES

100 836

70 % microfibre
(80 % polyester /
20 % polyamide)
20 % polyester
10 % polypropylène

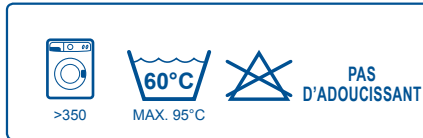

Description : Mop microfibre de nettoyage vapeur et sols lisses nouvelle génération

Conditionnement : Cartons de 10 sachets de 10 Ultimate M600

Construction : Tricot à plat

Poids au m² : 520 g

Poids sec : 94 g

Poids essoré : 215 g

Imprégnation : /

Finition : Surjet technique

Finesse du fil : 0,20 dTex



TECHNOLOGIE BREVETÉE

L'ULTIMATE est la seule technologie capable d'augmenter la proportion de microfibre pour plus d'efficacité sans affecter la glisse au sol pour plus d'ergonomie.

TECHNOLOGIE ULTIMATE

BREVET DÉPOSÉ

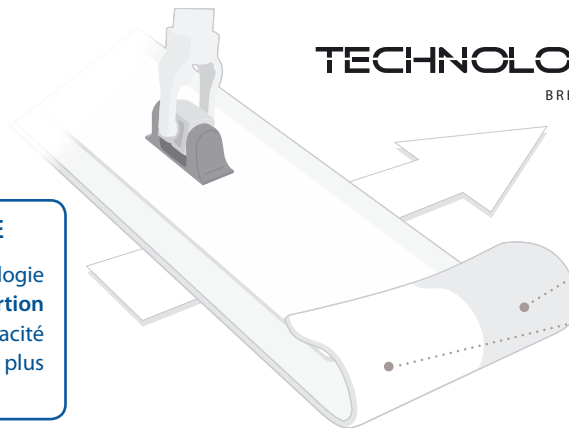

CÔTÉ QUI FACILITE LA GLISSE

Alternance de microfibras et fibres grattantes

CÔTÉ QUI DÉGRAISSE EN PROFONDEUR

100 % microfibre



ULTIMATE Dispomop®



ULTIMATE 3D®

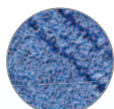

ULTIMATE M600



ULTIMATE Dx1



ULTIMATE Duo - grey



ULTIMATE Duo - white

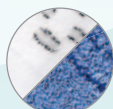

ULTIMATE DeLux



SMART TEXTILES

ULTIMATE M600

FABRIQUÉ EN EUROPE
BREVET DÉPOSÉ

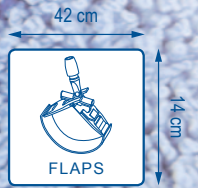

PROTOCOLE



Blocs opératoires / Services de réanimation



Services de santé



Maisons de retraite



Collectivités



Hôtels



Restaurants



Cafés



Entreprises de propreté



Industries

① Mouiller la mop



② Presser la mop dans le seau presse



③ Revenir vers l'entrée en utilisant la réserve de détergente



⚠ Précéder toujours le lavage d'un balayage.

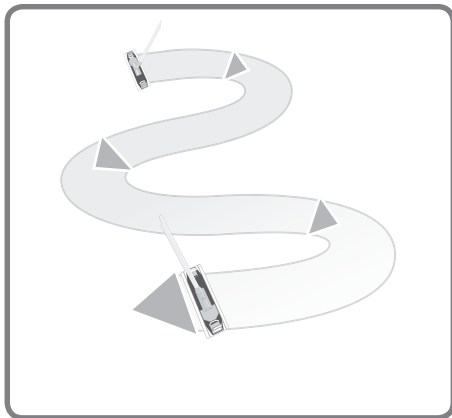

④ Mouiller et presser la mop dans le seau presse pour continuer le nettoyage

